



CDPW-V4H2HP

4 by 2 HDMI 4K UHD Wall Plate Matrix with HDCP 2.2



4K2K
HDCP2.2

Operation Manual

DISCLAIMERS

The information in this manual has been carefully checked and is believed to be accurate. Cypress Technology assumes no responsibility for any infringements of patents or other rights of third parties which may result from its use.

Cypress Technology assumes no responsibility for any inaccuracies that may be contained in this document. Cypress also makes no commitment to update or to keep current the information contained in this document.

Cypress Technology reserves the right to make improvements to this document and/or product at any time and without notice.

COPYRIGHT NOTICE

No part of this document may be reproduced, transmitted, transcribed, stored in a retrieval system, or any of its part translated into any language or computer file, in any form or by any means—electronic, mechanical, magnetic, optical, chemical, manual, or otherwise—without express written permission and consent from Cypress Technology.

© Copyright 2011 by Cypress Technology.

All Rights Reserved.

Version 1.1 August 2011

TRADEMARK ACKNOWLEDGMENTS

All products or service names mentioned in this document may be trademarks of the companies with which they are associated.





SAFETY PRECAUTIONS

Please read all instructions before attempting to unpack, install or operate this equipment and before connecting the power supply.

Please keep the following in mind as you unpack and install this equipment:

- Always follow basic safety precautions to reduce the risk of fire, electrical shock and injury to persons.
- To prevent fire or shock hazard, do not expose the unit to rain, moisture or install this product near water.
- Never spill liquid of any kind on or into this product.
- Never push an object of any kind into this product through any openings or empty slots in the unit, as you may damage parts inside the unit.
- Do not attach the power supply cabling to building surfaces.
- Use only the supplied power supply unit (PSU). Do not use the PSU if it is damaged.
- Do not allow anything to rest on the power cabling or allow any weight to be placed upon it or any person walk on it.
- To protect the unit from overheating, do not block any vents or openings in the unit housing that provide ventilation and allow for sufficient space for air to circulate around the unit.

REVISION HISTORY

VERSION NO.	DATE (DD/MM/YY)	SUMMARY OF CHANGE
VR0	27/10/15	Preliminary release



CONTENTS

1. Introduction	1
2. Applications	1
3. Package Contents	1
4. System Requirements	1
5. Features	1
6. Operation Controls and Functions	2
6.1 Top Panel	2
6.2 Left Panel	3
6.3 Right Panel	3
6.4 Bottom Panel	4
6.5 Remote Control	4
6.6 IR Cable Pin Assignment.....	5
6.7 RS-232 Protocol.....	5
6.8 RS-232 and Telnet Commands	6
6.9 Telnet Control	7
6.10 WebGUI Control	9
7. Connection Diagram	10
8. Specifications	11
8.1 Technical Specifications	11
8.2 Supported Resolutions	12
9. Acronyms	13





1. INTRODUCTION

This 4 by 2 HDMI Wall Plate Matrix is an advanced HDMI solution designed for Ultra High-Definition signal distribution needs. It allows you switch between and distribute one of four 6G HDMI inputs to two simultaneous 6G HDMI outputs. It has support for the latest HDMI features such as support for 4K2K@60 resolution, 48-bit 'Deep Color', high definition audio and more. The device can be easily operated through RS-232, Telnet, WebGUI, IR remote and on-panel controls.

2. APPLICATIONS

- Entertainment Room / Home Theater
- Show Room / Demo Room
- Lecture Room/Hall Presentation
- Show Room/Demo Room
- Public Commercial Display

3. PACKAGE CONTENTS

- 1×4 by 2 HDMI 4K UHD Matrix with HDCP2.2
- 1×Remote Control with Battery
- 1×Left & Right Rack Ears
- 1×5V/2.6A DC Power Adaptor
- 1×IR Receiver Cable
- 1×Operation Manual

4. SYSTEM REQUIREMENTS

Input source equipment such as Blu-ray/DVD/PS3 player or Set-Top-Box and output HDMI TV/Display and or audio amplifier with connection cables.

5. FEATURES

- HDMI with 6G 4Kx2K supported and HDCP 2.2 compliant
- Supports 4 HDMI inputs of one 6G and 2 HDMI outputs of two 6G
- Supports HDTV resolutions up to 4Kx2K: 3840x2160@24/25/30 Hz
3840x2160@50/60 Hz (4:4:4) & 4096x2160 @24/25/30 Hz,

4096x2160@50/60 Hz (4:4:4)

- Supports data rate up to 6Gbps (600MHz) and Deep Color up to 1080p 48-bit
- Supports pass-through of HD audio formats of LPCM 2/5.1/7.1CH, Dolby Digital 2~5.1CH, DTS 2~5.1CH, Dolby Digital Plus, Dolby TrueHD, Dolby Atmos and DTS-HD Master Audio
- Compliant with DVI sources with an HDMI-DVI adaptor

6. OPERATION CONTROLS AND FUNCTIONS

6.1 Top Panel

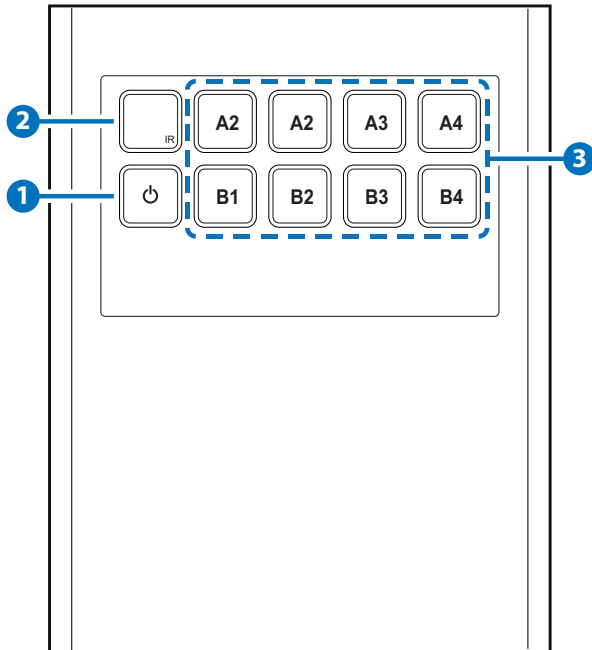

- 1 POWER:** Press the Power key to turn on the device and the LED will illuminated in green, press again to set it to standby mode and the LED will turn red. This device obtain power last memory function therefore, when power supply is re-plugged it will return to last power status.



- 2 IR Window:** This IR Receiver receives IR signal from the remote control included in the package only. Ensure that remote being used is within the direct line-of-sight of the IR window.
- 3 OUTPUT A1~A4 & B1~B4:** Press these buttons to change the routing of output with an input A/B.

6.2 Left Panel

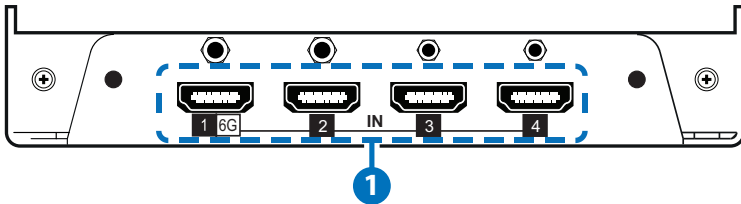

- 1 HDMI IN 1~4:** Connect from source equipment such as Blu-ray/DVD/PS3 player, Set-Top Box or any HDMI equipped source devices.
Note: Only port 1 supports 6G signal and other ports support up to 3G signal.

6.3 Right Panel

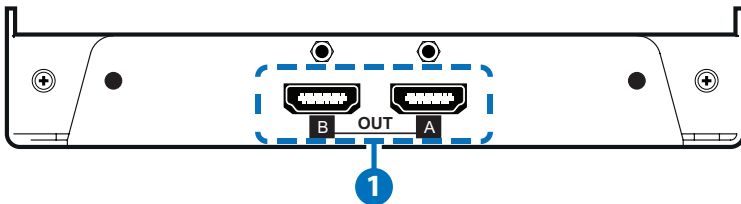

- 1 HDMI OUT A~B:** Connect to HDMI TV/display or HD amplifier for output audio and video image display up to 6G each port. The device will be base on output A's EDID for source's reference and if output A is not connected, the device will send the last connected output A's EDID. To remove EDID last memory, simply re-power on the unit without output A connected to any TV/display.

6.4 Bottom Panel

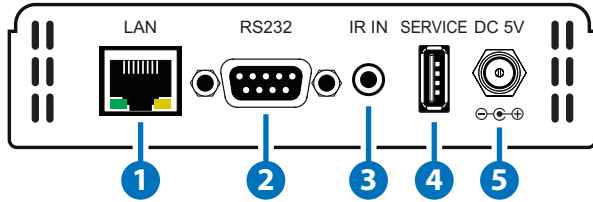

- 1 **LAN:** Connect to PC/Laptop with active internet service for Telnet/ WebGUI control with RJ-45 terminated cable.
- 2 **RS232:** Connect to PC/Laptop with D-Sub 9- pin female cable for the transmission of RS-232 commands to control the device.
- 3 **IR IN:** Connect the IR Receiver cable from the package for receive IR signal from the remote control.
- 4 **SERVICE:** This is reserved for firmware update use only.
- 5 **DC 5V:** Connect with adapter included from the package and connect to AC wall outlet for power supply.

6.5 Remote Control

- 1 **POWER:** Press Power key to turn on the device or set to standby mode.
- 2 **OUTPUT A1~A4 & B1~B4:** Press these buttons to change the routing of output A/B

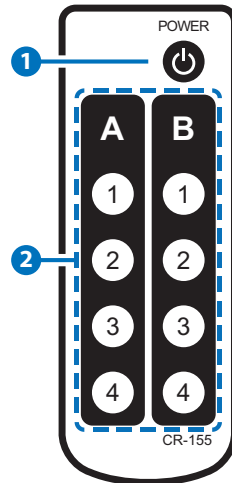

6.6 IR Cable Pin Assignment

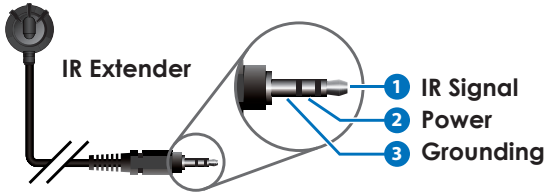

6.7 RS-232 Protocol

MATRIX	
Pin	Assignment
1	NC
2	TxD
3	RxD
4	NC
5	GND
6	NC
7	NC
8	NC
9	NC



REMOTE CONTROLLER	
Pin	Assignment
1	NC
2	RxD
3	TxD
4	NC
5	GND
6	NC
7	NC
8	NC
9	NC

Baud Rate: 19200bps

Data bit: 8 bits

Parity: None

Flow Control: None

Stop Bit: 1

6.8 RS-232 and Telnet Commands

COMMAND	DESCRIPTION	PARAMETERS
?	PRINT OUT ALL OF AVAILABLE COMMANDS	
HELP	PRINT OUT ALL OF AVAILABLE COMMANDS	
P0	POWER OFF	NONE
P1	POWER ON	NONE
A N	SET OUTPUT A SOURCE	N= Input 1~ 4
B N	SET OUTPUT B SOURCE	N= Input 1~ 4
IPCONFIG	DISPLAY THE CURRENT IP CONFIG	NONE
SIPADDR x.x.x.x	SET ETHERNET IP ADDRESS	x=0~255
SNETMASK x.x.x.x	SET ETHERNET NETMASK	x=0~255
SGATEWAY x.x.x.x	SET ETHERNET GATEWAY	x=0~255
HTTPPORTN	SET HTTP PORT NUMBER	N= 10~65500
IPMODE 0/1	SET IP MODE	(0=STATIC, 1=DHCP)
RSTIP	IP CONFIGURATION RESET TO DEFAULT(STATIC)	IP MODE : STATIC IP ADDR : 192.168.1.50 NETMASK : 255.255.255.0 GATEWAY : 192.168.1.1 HTTP PORT : 80 TELNET PORT: 23
ST	DISPLAY CURRENT ROUTING STATUS AND FIRMWARE VERSION	
REBOOT	REBOOT THIS MATRIX	
UPDATE	FIRMWARE UPDATE	

COMMAND	DESCRIPTION	PARAMETERS
FADEFAULT	SET ALL CONFIGURATIONS TO FACTORY DEFAULT	

Note: Any commands will not be executed unless followed by a carriage return. Commands are case-insensitive.

6.9 Telnet Control

Before attempting to use the Telnet control, please ensure that both the Matrix (via the 'LAN /CONTROL' port) and the PC/Laptop are connected to the same active networks.

To access the Telnet control in Windows 7, click on the 'Start' menu and type "cmd" in the Search field then press enter.

Under Windows XP go to the 'Start' menu and click on "Run", type "cmd" with then press enter.

Under Mac OS X, go to Go→Applications→Utilities→Terminal
See below for reference.

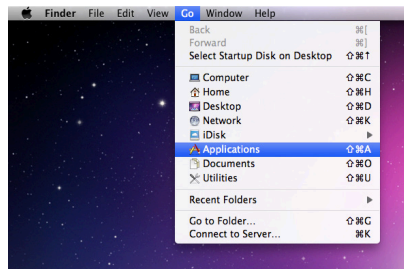
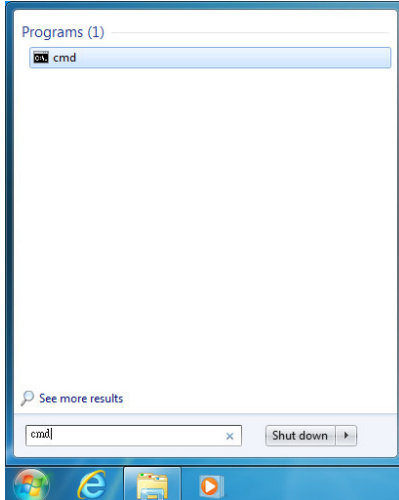

Once in the command line interface (CLI) type "telnet", then the IP address of the unit and "23", then hit enter.

```
Microsoft Windows [Version 6.1.7601]
Copyright (c) 2009 Microsoft Corporation. All rights reserved.

C:\Users\Administrator>telnet 192.168.5.80 23
```

This will bring us into the unit which we wish to control. Type "help" to list the available commands.

```
Welcome to TELNET.
?

Command List
-----
HELP
P0
P1
A
B
IPCONFIG
$IPADDR
$NETMASK
$GATEWAY
HTTPOPT
IPMODE
RSTIP
ST
REBOOT
UPDATE
FADEFAULT
```

Note: Commands will not be executed unless followed by a carriage return. Commands are case-insensitive. If the IP is changed then the IP Address required for Telnet access will also change accordingly.

6.10 WebGUI Control

On a PC/Laptop which is connected to an active network system, open a web browser and type device's IP address (factory default static IP: 192.168.1.50) on the web address entry bar. The browser will display the device's control page for users to control.

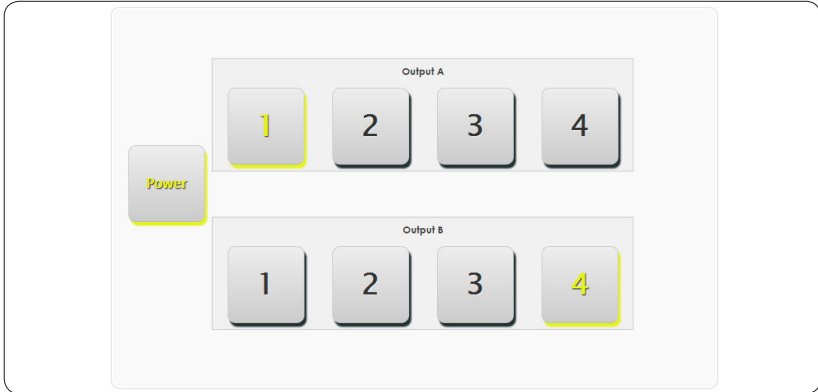

7. CONNECTION DIAGRAM

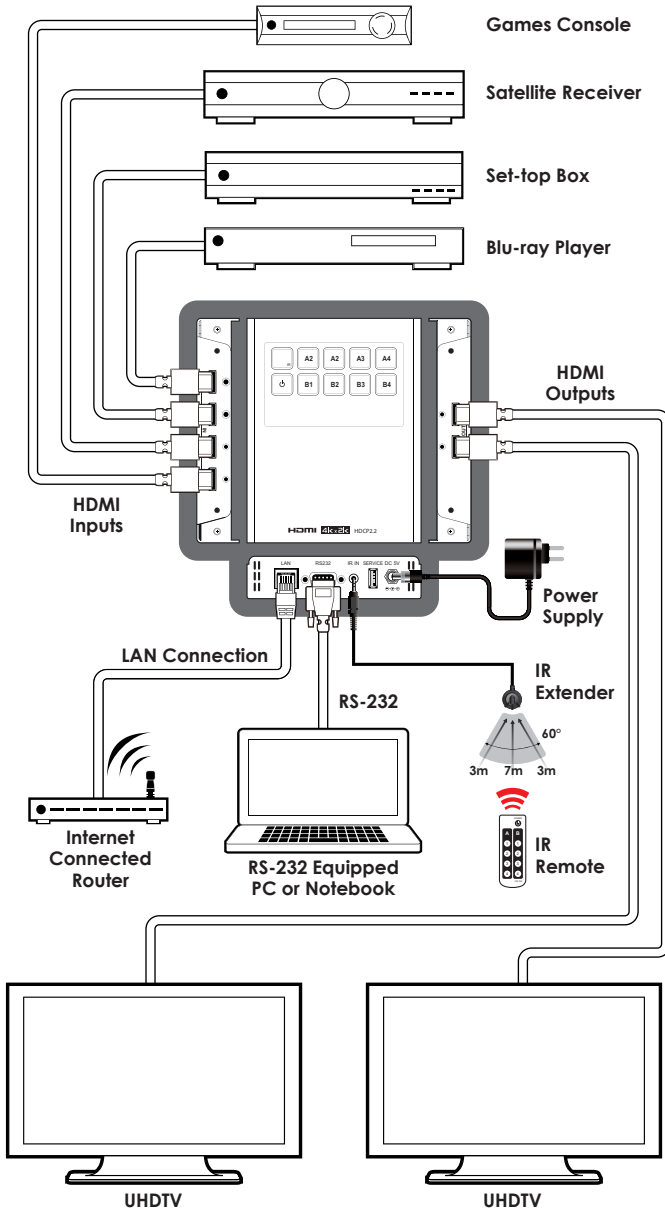



8. SPECIFICATIONS

8.1 Technical Specifications

Video Bandwidth	600MHz/6 Gbps
Input Ports	4×HDMI, 1×IP Control (RJ-45), 1×IR, 1×RS-232 (9-pin D-sub), 1×USB (Service only)
Output Ports	2×HDMI
Supported Resolutions	480i~1080p@24/50/60, 4K2K@24/25/30/50/60 & VGA~WUXGA
HDMI Cable Length	I:15M/1080p@12bits, 5M/4K2K O:15M/1080p@12bits, 5M/4K2K
IR Frequency	38 kHz
Baud Rate	19200 bps
Power Supply	5V/2.6A DC (US/EU standards, CE/FCC/UL certified)
ESD Protection	Human body model: ±8 kV (air-gap discharge) ±6 kV (contact discharge)
Dimensions	120 mm (W)×155 mm (D)×31 mm (H)/ Jack Excluded 150 mm (W)×162 mm (D)×31 mm (H)/ Jack Included
Weight	744 g
Chassis Material	Metal
Color	Black
Operating Temperature	0°C~40°C/32°F~104°F
Storage Temperature	-20°C~60°C/-4°F~140°F
Relative Humidity	20~90% RH (non-condensing)
Power Consumption	5.5W

8.2 Supported Resolutions

Resolution	Input	Output
640×480@60/72/75/85	√	√
720×480@60	√	√
720×576p@50	√	√
800×600@60/72/75/	√	√
1024×768@60/70/75	√	√
1280×720@50/60	√	√
1280×720p@60	√	√
1280×768@60	√	√
1280×800@60	√	√
1280×1024@60	√	√
1360×768@60	√	√
1600×1200@60	√	√
1920×1080i@50	√	√
1920×1080i@60	√	√
1920×1080p@24/25/30/50/60	√	√
1920×1200@60(RB)	√	√
3840×2160@24/25/30/50/60	√	√
4096×2160@24/25/30/50/60	√	√

9. ACRONYMS

ACRONYM	COMPLETE TERM
CEC	Consumer Electronics Control
CLI	Command Line Interface
DTS	Digital Theater System
DVI	Digital Visual Interface
EDID	Extended Display Identification Data
GUI	Graphical User Interface
HDCP	High-bandwidth Digital Content Protection
HDMI	High-Definition Multimedia Interface
HDTV	High-Definition Television
IP	Internet Protocol
IR	Infrared
USB	Universal Serial Bus
VGA	Video Graphics Array
WUXGA (RB)	Widescreen Ultra Extended Graphics Array (Reduce Blanking)



CYPRESS TECHNOLOGY CO., LTD
Home page: <http://www.cypress.com.tw>

MPM-V4H2HP